



**USER
MANUAL**

T01 V
SMART LOCK

www.smartleelen.com

Menu

1 Important Information

- 1.1 Security
- 1.2 Warning
- 1.3 Disposal Of Old Products And Batteries

2 Install The Lock

- 2.1 Product List
- 2.2 Installation Three-dimensional Assembly Drawing
- 2.3 Instructions Before Installation
- 2.4 Bolt Direction Reversing
- 2.5 Removing the anti-pinch baffle

3 Lock Appearance

- 3.1 Appearance

4 Set Up The Lock

- 4.1 Change Language Fastly
- 4.2 Enter The Management Mode
- 4.3 Add Unlocking Methods
- 4.4 Delete Unlocking Methods
- 4.5 Management Settings
- 4.6 System Settings
- 4.7 Other Settings
- 4.8 Installation Video

5 Use The Lock

- 5.1 Outdoor Locking/Unlocking
- 5.2 Indoor Locking/Unlocking

6 Other Functions

- 6.1 Restore Factory Settings
- 6.2 Battery Replacement
- 6.3 Emergency Power Supply Method
- 6.4 System Restart

7 Basic Parameters

8 Restricted Substances

1 Important Information

1.1 Security

- Before using this smart lock, please read and understand all instructions. Damage caused by failure to follow the instructions is not covered by the warranty
- Suggest using accessories specified by our company
- Only use the lithium battery configured for this product
- Do not disassemble the product forcibly, so as not to sound an alarm or damage the product
- Do not scratch the fingerprint sensor with sharp objects, or it may cause permanent damage
- Do not expose the product to corrosive substances, so as not to damage the protective layer of the shell
- Do not hang objects on the handle, so as not to affect the normal use of the door lock
- To clean the product, please wipe it with a soft cloth
- Do not remove the battery while the device is in operation
- Please choose a professional engineer to install the door lock, and follow the company's installation standards, and do not disassemble or assemble by yourself
- After the door lock is installed and debugged, please modify the default management password set at the factory as soon as possible and keep the mechanical key properly, and do not disclose the password information easily
- After the door lock triggers the low battery alarm, please replace all batteries in time and make sure the installation is correct

1.2 Warning

- Do not put the battery near the fire, so as not to explode
 - Do not use an emergency power source that does not comply with safety regulations to power this product
 - Do not short-circuit the pole connections of the battery leads with metal as this may cause an explosion
 - Make sure to replace by LEELEN, LEELEN authorized service centers or professionals
 - Using accessories or components produced by other manufacturers or not specifically recommended by LEELEN may invalidate your warranty
-

1.3 Disposal Of Old Products And Batteries

- Please understand the local electronic product classification collection system by yourself
- Please follow local regulations and do not dispose of old batteries in normal household waste
- Proper disposal of old products helps avoid potential negative impacts on the environment and human health
- Batteries cannot be disposed of with normal household waste

2 Install The Lock

2.1 Product List

This product list is for reference only, and everything is subject to the actual packaging content.

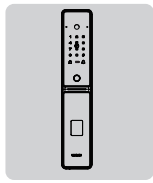

Front Panel
(with silicone pad)
x1

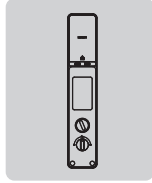

Rear Panel
(with silicone pad)
x1

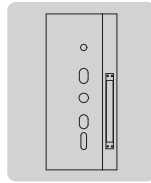

Opening Template
x1

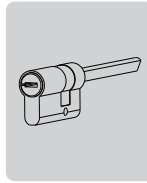

Automatic
lock core
x1

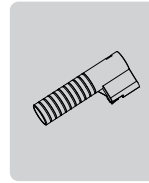

Lock core
positioning sleeve
x1

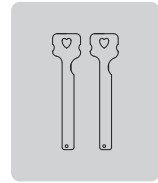

Mechanical
Key
x2



IC Card
x2



Installation Kit
x1



User's Guide
x1

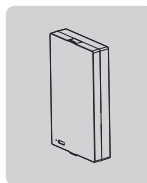

5000mAh Battery
x1

2.2 Installation Three-dimensional Assembly Drawing

Knowing the three-dimensional assembly diagram of the installation is conducive to understanding the structure of the lock.

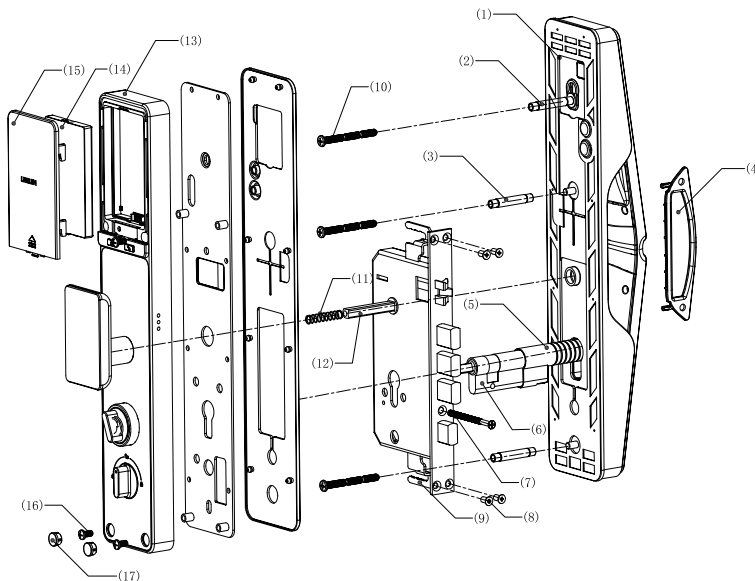

1. Door outer lock assembly (1 set)
2. Carriage screw assembly (1 pcs)
3. Connecting studs (2 pcs)
4. Anti-pinch hand stop (2 pcs)
5. Lock core positioning sleeve (1)
6. Lock cylinder (1)
7. Lock cylinder fixing screw (1 pcs)
8. Lock body fixing screws (4 pcs)
9. Lock body (1)
10. Connecting screw (2)
11. Square rod spring (1 pcs)
12. Square rod (1)
13. Door lock assembly (1 set)
14. Lithium battery (1)
15. Battery cover (1)
16. Door inner lock fixing screws (4 pcs)
17. Silicone stopper (2 pcs)

2.3 Instructions Before Installation

2.3.1 Confirm the door opening direction before installation

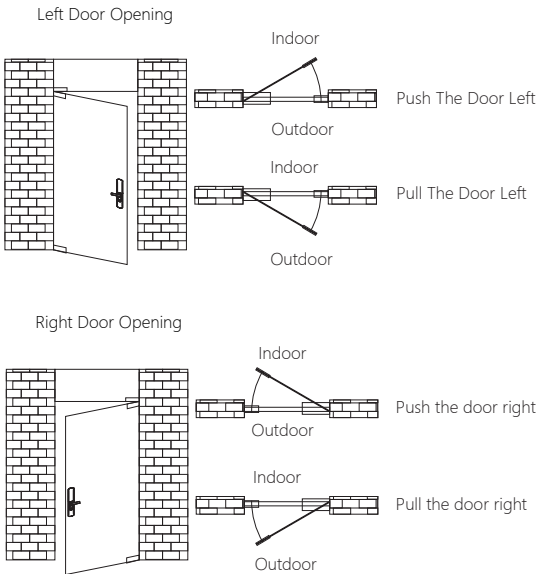

2.3.2 Corresponding lock body and bolt direction

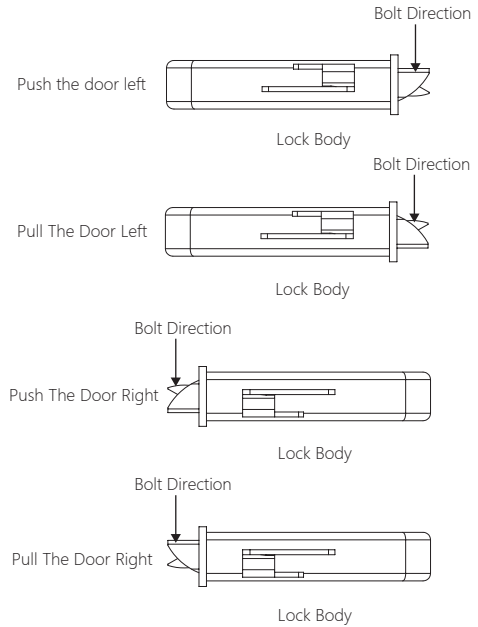

2.4 Bolt Direction Reversing

The lock body does not distinguish between push in and pull out. If you need to change the direction (that is, push in to pull out, or pull out to push in), please adjust the direction of the bolt before installation. The specific method is as follows:

- ① The main bolt remains locked
- ② Slightly lift outward, the bolt will automatically pop out of the side panel
- ③ Rotate the latch 180°
- ④ Press the bolt into the side panel after swiveling into position

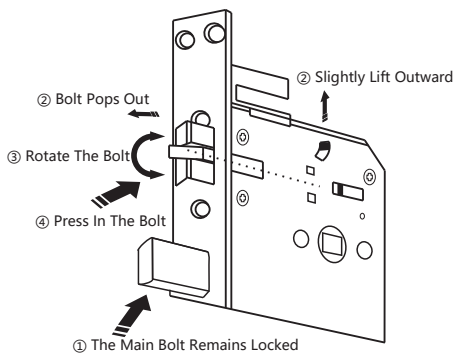

2.5 Removing the anti-pinch baffle

According to the installation direction of the smart lock, after the installation is completed, the anti-pinch baffle on the side near the door gap needs to be removed. Insert your fingers into the clasp of the bezel and gently push it outward to remove the bezel. Keep the baffle close to the door frame to prevent hands from being pinched by opening and closing the lock with the wrong posture.

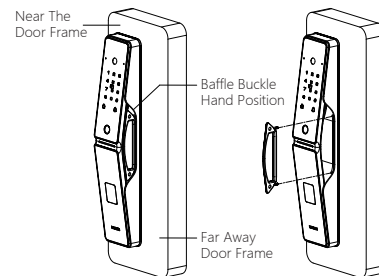

3 Lock Appearance

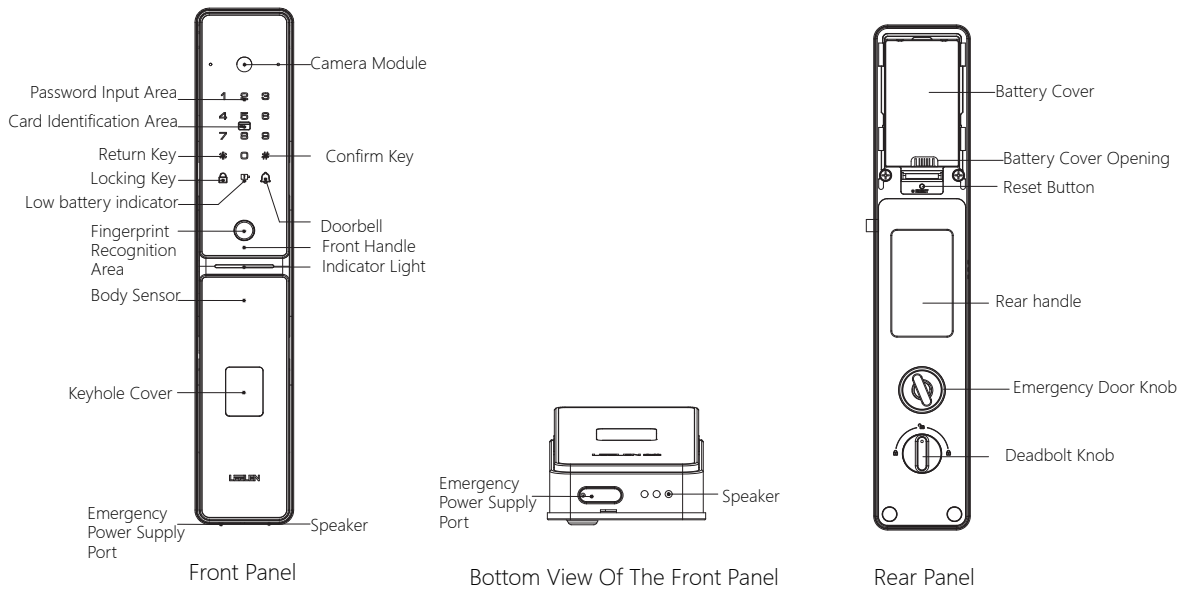

4 Set Up The Lock

4.1 Change Language Fastly

Long press the **5** key for 10S, the device enters the state of rapid language switching, at this time the voice will prompt "Language switching Settings: English press 1, Vietnamese press 2, Thai please 3, Indonesian press 4, Arabic press 5, hard to hear press #, return press *". The user presses the corresponding numbers 1-5, and it prompts :the operation is successful.

4.2 Enter the Management Mode



- 1.Touch the keyboard area with the back of your hand, the keyboard light will light up, and wake up the keyboard.
- 2.Press and hold the # key for 2 seconds, enter the management password after hearing the voice prompt, and press # to confirm.(default password: 951058)
- 3.After hearing the menu prompt it means that it has entered the management mode.

Note: If the management password is the default password, it is recommended to modify the management password before performing other operations.

4.3 Add Unlocking Methods

In Management Mode:
When adding a user, the door lock will automatically number the user key, and the user only needs to enter fingerprints, passwords or cards according to the prompts.

Press **1** to add a user,Press the **2** key to add fingerprints, and follow the voice prompts to change different angles to enter fingerprints until it prompts: the operation is successful.

Press **1** to add a user,Press the **2** key to enter to add a password. After entering the 6-digit password, enter the password again according to it prompts until the prompt: the operation is successful.

Press **1** to add a user,Press the **2** key to enter the card adding put the card in the card recognition area, until it prompts: the operation is successful.

4.4 Delete Unlocking Methods

In Management Mode:

Press the **2** key to delete the unlocking method, enter the user number according to the voice prompt, press # to confirm, until it prompts: the operation is successful.

4.5 Management Settings

4.5.1 Change the management Password

In Management Mode:

Press the **3** key to enter the management settings, and then press the **1** key to modify the management password. After entering a new 6-digit management password, follow the voice prompts and enter the management password again until it prompts: the operation is successful.

4.5.2 Add the management Fingerprint

In ManagementMode:

Press the **3** key to enter the management settings, and then press the **2** key to add the management fingerprints, according to the voice prompts, change the fingerprints from different angles until it prompts: the operation is successful.

4.5.3 Delete the management Fingerprint

In Management Mode:

Press the **3** key to enter the management settings, and then press the **3** key to delete the management fingerprint. According to it prompts, press the # key to confirm until it prompts: the operation is successful.

4.6 System Settings

4.6.1 Volume Settings

In Management Mode:

Press the **4** key to enter the system settings, and then press the **1** key to set the volume. According to the voice prompt, press **1** to set the high volume, press **2** to set the medium volume, press **3** to set the low volume, and press **4** to set the mute. Until the voice prompt: the operation is successful.

Note: No matter which volume mode is set, the menu indicator sound, alarm sound, and factory reset prompt sound will always maintain a medium volume.

4.6.2 Illegal Input Times Settings

In ManagementMode:

Press the **4** key to enter the system settings, and then press the **2** key to enter the number of illegal unlocking settings. According to the prompt, enter the unlocking times of 5-9, press # to confirm, until it prompts: the operation is successful.

Note: After the setting is completed, if the user fails to unlock for more than the above times, an alarm will be triggered.

4.6.3 Remote Unlocking Settings

In Management Mode:

Press the **4** key to enter the system settings, then press the **3** key to enter the remote unlocking settings, and press the **1** key to enable it, press the **2** key to disable it, until it prompts: the operation is successful. Remote unlocking is disabled by default.

4.6.4 Card Encryption Settings

In Management Mode:

Press the **4** key to enter the system settings, then press the **4** key to enter the card encryption setting, press the **1** key to enable it, press the **2** key to disable it, until it prompts: the operation is successful. Encryption is enabled by default.
In Admin Mode:

▲
After opening, the use and entry of the card can be more secure and cannot be copied. After closing, the security level of the card is reduced, but the applicability is enhanced, such as the door lock can be opened by copying the card through the mobile phone.

4.6.5 Delayed Locking Settings

Press the **4** key to enter the system settings, then press **5** key to enter the delayed locking settings, press **1** key to enable it, press **2** key to disable it, until it prompts: the operation is successful. Delayed locking is enabled by default. When delayed locking is enabled, the lock bolt will be automatically activated in 15 seconds after the smart lock is successfully unlocked.

4.6.6 Residency Alarm Settings

In ManagementMode:

Press the **4** key to enter the system settings, then press the **6** key to enter the residency alarm settings, and press the **1** key to enable it, press the **2** key to disable it, until it prompts: the operation is successful. Residency alarm is disabled by default.

4.6.7 Double Verification Settings

In Management Mode:

Press the **4** key to enter the system settings, then press the **7** key to enter the double verification settings, and press the **1** key to enable it, press the **2** key to disable it, until it prompts: the operation is successful. Double verification is disabled by default.

4.6.8 Language Changing Settings

In Management Mode:

Press the **4** key to enter the system settings, then press the **8** key to enter the language changing settings, and press the 1~5 key to select a language. Completed when it prompts:the operation is successful.Language is English by default.

4.7 Other Settings

4.7.1 Demo Mode Settings

In Management Mode:

Press the **4** key to enter the system settings,Press the **0** key for 2 seconds to turn on/off the demo mode, and the it prompts "Demo mode on!"/"Demo mode off".

Note: The demo mode option will appear in the system only after the door lock has not been added any unlocking credentials, modified the management password, or restored to factory settings.

4.7.2 Commutation Settings



If no unlocking credentials are added to the door lock or after the door lock is restored to factory settings, press the **8** key three times in succession, and then press the # key to confirm. Then press the **1** key to switch the right door opening direction; press the **2** key to switch the left door opening direction.

4.7.3 Mute Mode Settings



Wake up the keyboard, press and hold the 0 key for 2 seconds to enter mute mode, so you can go home at night without waking up your sleeping family members.

Note: Mute mode will be released when the door lock goes to sleep or enters management settings. In mute mode, the video call function is not affected.

4.8 Installation Video

During the door lock installation process, it is necessary to try dangerous professional tools, so please be sure to hire a professional to install it. Before installation, please scan the QR code on the right, watch and follow the installation video to complete the installation.



5 Use The Lock

5.1 Outdoor Locking/Unlocking

Password Unlocking

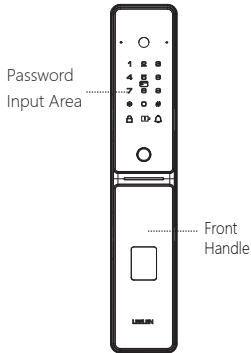

Outdoor | Front Panel

Touch or swipe the keypad to wake it up, enter the password and press # to confirm. After the verification is successful, Please push or pull the handle to open the door within 3 seconds

Proximity Card Unlocking

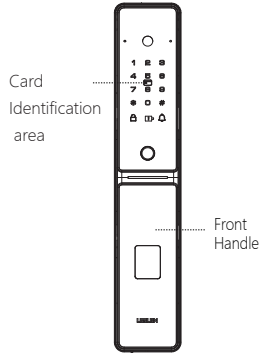

Outdoor | Front Panel

Tap an added card key on the identification area. After the verification is successful, Please push or pull the handle to open the door within 3 seconds

Fingerprint Unlocking

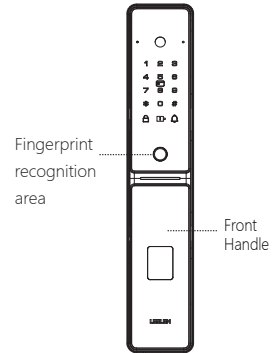

Outdoor | Front Panel

Put an added finger on the fingerprint recognition area. After the verification is successful, Please push or pull the handle to open the door within 3 seconds

- ▲ If the wrong unlocking credentials (password/card/fingerprint) are entered continuously within 5 minutes, the smart lock will be locked for 90 seconds. After successful unlocking, if the door is not opened within 5 seconds, the smart lock will re-lock automatically.

Key Unlocking

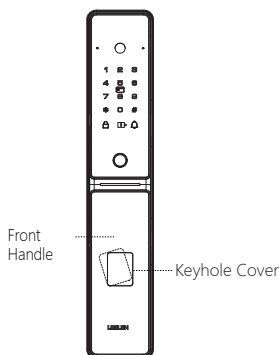

Outdoor | Front Panel

Press and hold the top of the inner keyhole cover, turn the battery cover left, insert the keyhole and turn to unlock, push/pull the handle to open the door.

- ▲ Do not leave emergency keys inside the house. Keep them in a safe and accessible place for use in extreme situations.

Key Locking

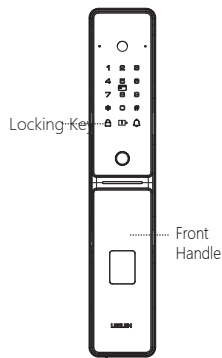

Outdoor | Front Panel

After closing the door, press the lock key to lock the door. During this period, you can click the illuminated 8 button to activate the arming function.

5.2 Indoor Locking/Unlocking

Indoor Locking

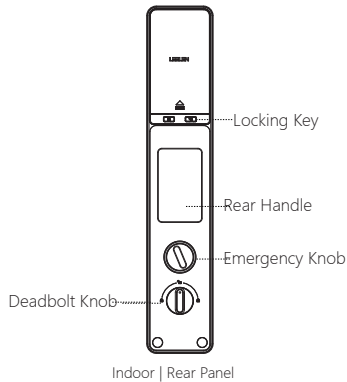

- ① Press the unlocking button, and after hearing the unlocking tone, push/pull the quick-open handle to open the door within 3 seconds.
- ② According to the actual door opening direction, rotate the quick-open handle to open the door.
- ③ For emergency opening, rotate the Emergency Knob to open the door.

Indoor Unlocking

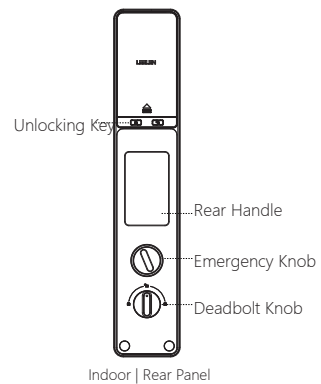

- ① After closing the door, press the locking button to lock it.
- ② According to the actual locking direction, rotate the quick-open handle to lock.

6 Other Functions

6.1 Restore Factory Settings

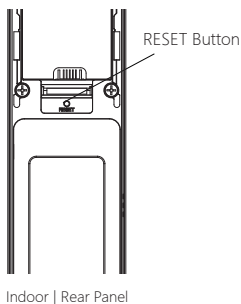

As shown in the figure, after long pressing the RESET button located on the inner lock of the door for 5 seconds, according to the voice prompt, short press the RESET button within 10s until it prompts "operation is successful", then the factory settings are restored successfully.

6.3 Emergency Power Supply Method

When the battery voltage is insufficient and cannot be opened from the outside, you can open the rubber plug of the power supply port at the bottom of the front panel, connect a power supply bank to the emergency power supply port (Type-C), and then use your fingerprint, password or card to unlock.

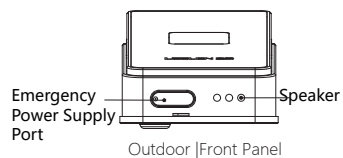

6.2 Battery Replacement

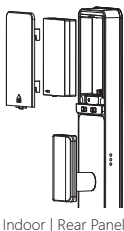

When the system voice prompts "The battery is low, please replace the battery", it is necessary to replace the corresponding part of the battery in time.

6.4 System Restart

If you need to restart the system, you can use a 5V power bank as an emergency power supply and power on the door lock through the Type-C interface to restart.

7 Basic Parameters

Front panel (L*W*H): 413×79×56.25mm
 Rear panel (L*W*H): 413×79×73mm
 Shell Material: 6 series aircraft grade aluminum alloy +Tempered Glass
 Lock body type: 6068 standard lock body/Overlord lock body
 Input power: 5000mAh Lithium Battery
 Emergency power supply interface: Type-C 5V power supply port
 Wifi Module:Wi-Fi IEEE 802.11b/g/n 2.4GHz
 Working temperature: -25°C~+70°C
 Working humidity: 0~93%±3%RH, non-condensing
 Protection class: IP52
 User capacity:
 100 fingerprint (99+1 management)/
 50 password groups (49+1 management)/
 100 cards
 Environmental adaptability level: Level II
 Product safety level: Class B
 Lock cylinder security level: C level
 Suitable for door thickness: standard 50mm~130mm

8 Restricted Substances

Part Name	Toxic and hazardous substances or elements					
	Pb	Hg	Cd	Cr6+	PBB	PBDE
Metal Parts	○	○	○	○	○	○
Plastic Parts	○	○	○	○	○	○
Board Assembly*	X	○	○	○	○	○
Power Cord/Connection Cord	X	○	○	○	○	○
Lithium Battery	X	○	○	○	○	○

This form is prepared according to the provisions of SJ/T 11364:
 ○: Indicates that the content of the hazardous substance in all homogeneous materials of the part is below the limit requirement in GB/T 26572
 X: Indicates that the content of the hazardous substance in at least one homogeneous material of the part exceeds the limit requirement specified in GB/T 26572
 *: Circuit board assembly includes printed circuit board and its components, such as resistors, capacitors, integrated circuits, etc.